

Dedicated to Anssi Karttunen

Kaija Saariaho

Petals

for cello solo
with optional electronics

Duration: approx. 9 min.

*Premiered by Anssi Karttunen
at the Musica Nova Festival, Bremen
on May 19th 1988*

Edition Wilhelm Hansen Helsinki AB

Petals

When vibrato markings are not specified, players can use their usual vibrato. *Molto vibrato* always means a rapid and narrow vibrato, unless otherwise specified. Tremolo should always be as dense as possible.

General marks

 change very gradually from one sound or one way of playing (etc) to another

 diminuendo al niente

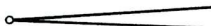
 crescendo da niente

S.V. senza vibrato

▲ highest note possible



Microintervals



♯ note raised a 1/4 tone (between ♭ and ♯ upwards)

♭ note lowered a 1/4 tone (between ♭ and ♭ downwards)

Glissandi

For glissandi there are three different notations:

 or  this glissando should always be played very evenly, without vibrato and accentuations

 or  glissando with much vibrato

 glissando with artificial harmonics, in which the upper finger is constantly moving and thus creating a rich sound with vividly varying pitches, instead of one gliding pitch

All the glissandi should be started immediately at the beginning of the note value.

S.P. *always* estremamente sul ponticello

S.T. sul tasto

N normal (used with S.P. and S.T., otherwise ord.)

 move gradually from normal to harmonic sound (less and less pressure with the left hand)

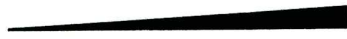
 add bow pressure to produce a scratching sound, in which the audible pitch is totally replaced by the noise

 as above but move back from noise to tone again

 (E.F.) decrease bow pressure to produce a soft, noise, windlike murmur

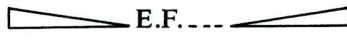
 E.F. decrease bow pressure to produce a soft, noisy, winds-like murmur for as long as E.F. (estramamente flautando) continues, and move then gradually back to normal bow pressure

 E.F. add bow pressure to produce a scratching sound, and decrease it gradually to produce the E.F. sound described above.

When playing long sustained tones the bow changes should always be made imperceptible.

Proposition for the set-up of the electronics

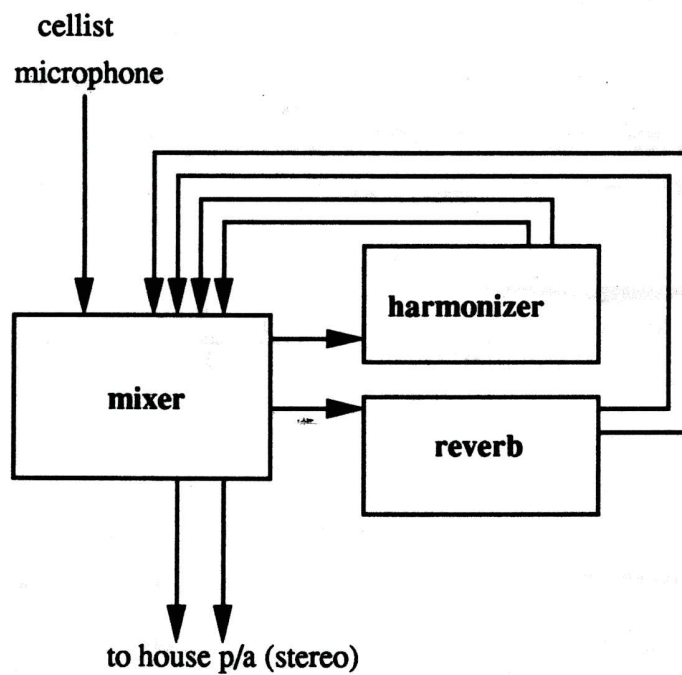

if SPX90 is used as harmonizer,
select programme 22 (pitch change B)
and set the parameters as follows:
-pitch1 +0/ fine1 +45/ delay1 20ms
-pitch2 +0/ fine2 -50/ delay2 15ms

Electronic version

For the electronic version the following are needed:

- at least one microphone for the amplification
- digital reverb with a variable reverb time
- harmonizer (Yamaha SPX90 or REV5: pitch change program, or possibly Publison, Eventide)
- at least two loudspeakers (possibly a monitor for the cellist)
- mixer (suggested set-up see p. 8)

The amplified sound is sent to both loudspeakers. The amount of amplification depends, naturally, on the concert space, but should not totally cover the acoustic sound of the instrument. The general level should not grow enormously when the degree of effects is added; here the straight amplified sound can be set slightly down. Nevertheless, no abrupt changes in the sound image should be made.

The sound ideal is a clear and rich 'close sound'. The microphone(s) should be placed as close to the instrument as possible.

The general level should be set to be rather loud, nevertheless not painfully so!

Harmonizer

The harmonizer should be set to produce microtonal pitch shifting, the transposition being about 50 cents (= 1/4 tone) on both sides of the input signal. If only one channel is available, the transposition is set one 1/4 tone higher.

If the SPX90 is used as harmonizer, select programme 22 (pitch change B) and set the parameters as follows:

pitch1 +0/fine1 +45/delay1 20ms

pitch2 +0/fine2 -50/delay2 15ms

If some other devices are used, a slight reverb can be added so soften the effect.

Reverb

If several reverb programs are available a bright reverberation should be selected without any other effects. At the beginning the reverb time should be set to about 2.5 seconds (depending on the hall), and possible filterings and other manipulations made to obtain a clear and bright sound. If the concert space is very dry, the instrumental sound can be slightly reverberated throughout the piece.

If the changing of reverberation time causes any clicks, it is better to choose a stable reverberation and accentuate the changes of reverb time by changing the amount of reverb. Generally: rather too little than too much reverb!

The notation of the electronics

The two effects are marked with R (reverb) and H (harmonizer). The changes in the degrees of the effects are marked approximately with crescendos or diminuendos from a previous level to a new level, or with dotted lines, which means that the current level is to be maintained.

The percentages marked are guidelines only, and will have to be adjusted every time depending on the performance space.

Kaija Saariaho

M.R. 76

REV 9/20/95

Petals

Kaija Saarial
(198

Lento (very slowly; the duration of every stave in this tempo should always be at least 20"!))

1

Vlc. *tr* *gliss.* *tr*

Etr. **R** \emptyset 40%

rev. time ca. 2,5"

2

Vlc. *tr* *tr*

Etr. **R** (40%) \emptyset 50%

mp *mf*

3

Vlc. *tr* *tr*

Etr. **R** (40%) \emptyset 50%

mf *ff*

4

\downarrow = ca. 60 *energico*

Vlc. *ff* 10 *ff* 10 *mf* 10

Etr. **R** (40%) \emptyset

5

Vlc. *mf* 10 *p* *mf* 10 *mf* 10

Etr. **R** (40%) \emptyset

6

Vlc. *mp* 10 *p* *mf* 10 *pp* *f* 10 *mf*

Etr. **R** (40%) \emptyset

7

Vlc. *mf* *gliss.* 10 *gliss.* *gliss.* *rit.* *pp*

Etr. **R** (40%) \emptyset

8

Lento

Vlc. *tr* *tr* *gliss.* *tr*

Etr. **R** (40%) \emptyset 50% 30'

ppp *pp* *ppp*

8va

9

Vlc. *tr* *tr* *tr* *tr*

Etr. **R** (40%) \emptyset 30%

ppp

♩ = ca. 54 *accel.* ----- ♩ = ca. 66

R 30%

poco agitato *rit.* *a tempo*

R (30%)

H ∅ 50% ∅

rit. *a tempo* *rit.* *a tempo* *a tempo*

R (30%)

rit. ♩ = ca. 40 **Lento**

R 30% 50% at least 12"

pp **SOL**

R (50%) **H** ∅ 20% ∅

gliss. **DO** *tr.* *mp*

R (50%) **H** ∅ 20% ∅ 40%

tr. *gliss.* *ppp* *mf*

R 40% **H** ∅ 50% ∅

♩ = ca. 60 *mf* *p* *mf* *mp* *mf rit.*

R (40%) 20%

rit. ----- a tempo

poco rubato

18

mf p f p f f p

40% 30% 40% > 20%

R
H

19

f p

40% > 20% 20%

R
H

20

ppp f ppp ff p

40% 20% 50%

R
H

21

ppp mp p

50% 30%

change gradually the rev. time ca. 15''

R

22

p ppp

30% 40%

(rev. time ca. 15'')

R

23

ff pp ff ff mp

50%

R
H

24

pp ff pp ff

50% 50%

R
H

5

R (20%)

H ∅

40%

50%

20%

40%

6

R 40%

H ∅

20%

30%

7

Lento

R 30%

H ∅

20%

30%

8

R (30%)

H ∅

30%

30%

9

mp sempre

R (30%)

H ∅

30%

30%

10

R 30%

H ∅

50%

50%

50%

50%

ca. 10"

at least 20"

at least 25"

ca. 30"

TIME

change gradually rev. time 15"